



DONGGI PNI
COSMETICS CONTAINER
MANUFACTURER

CONTENT

07

ReDi Series
AIRLESS



20

PUMP



13

ReDi Series
DIP TUBE



22

JAR TYPE

30

Process



26

Family Series

ECO FRIENDLY COSMETIC CONTAINER

DONGGIPNI는 차세대 친환경 화장품 용기 개발을 통해 고객에게 Vision을 제시하고자 합니다.

DONGGIPNI wants to present Vision to customers by developing next-generation eco-friendly cosmetics containers.

끊임없는 연구 개발과 신제품 개발 의지는 고객을 위한 DONGGIPNI의 약속입니다.

Continuous research and development and willingness to develop new products are DONGGIPNI promise for customers.

SPRINGLESS

철제 스프링이 없는 All Plastics Pump
All plastic pump that has no metal spring.

POM FREE

유해물질(포름알데하이드)을 발생 시키는 POM 파트가 없는 펌프
The pump is built without POM parts which cause formaldehyde.

LOW CARBON FOOTPRINT

기존 펌프에서 펌프 파트를 줄인 탄소 배출 저감 펌프
Reducing the number of the parts of the pump resulting
in low carbon footprint.

ReDi SERIES

DONGGIPNI Non-Metal Pump Technology로 완성된
ReDi Pump는 내일의 더 나은 환경을 위한 작은 해결책입니다.
(ReDi Pump is a small solution for a greener tomorrow.)

메탈을 사용하지 않고 플라스틱으로만 되어 있으며,
특허 기술로 100% 재활용이 가능합니다.
(Metal-less, all plastic and 100% recyclable pump with patented technology)

SPRINGLESS RECYCLABLE PUMP
 ReDi Series_ AIRLESS
 (SKINCARE VERSION)

SPRINGLESS RECYCLABLE PUMP
 ReDi Series_ DIP TUBE
 (SKINCARE VERSION)



S Type

Airless
 Dosage : 0.2cc
 Capacity :
 5,6,7,8,10,15ml

BR Type

Airless
 Dosage : 0.2cc
 Capacity :
 15,30,35,45,50ml

SR Type

Airless
 Dosage : 0.2cc
 Capacity :
 30,35,50ml

TR Type

Airless
 Dosage : 0.2cc
 Capacity :
 30,35,50ml

CR Type

Airless
 Dosage : 0.2cc
 Capacity :
 30,35,50ml

DS Type

Dip Tube
 Dosage : 0.2cc
 Capacity :
 30,50,80,100ml

DO Type

Dip Tube
 Dosage : 0.2cc
 Capacity :
 30,50,80,100ml

MIST / M0 Type

Dip Tube
 Dosage : 0.2cc
 Capacity :
 30,50,80,100ml

MIST / MR Type

Dip Tube
 Dosage : 0.2cc
 Capacity :
 30,50,80,100ml

에어리스 펌프

S TYPE

SPRINGLESS RECYCLABLE PUMP

ReDi Series_AIRLES

귀엽고 휴대가 간편한 Spring-less pump
Cute and easy to carry Spring-less pump



PRODUCT SPECS TABLE

CODE	CAPACITY(ml)	DIAMETER(mm)	HIGH(mm)	PUMP TYPE	DOSAGE(cc)
RD-05S	5			SNAP ON	0.2
RD-06S	6			SNAP ON	0.2
RD-07S	7			SNAP ON	0.2
RD-08S	8			SNAP ON	0.2
RD-10S	10			SNAP ON	0.2
RD-15S	15			SNAP ON	0.2

AVAILABLE SIZE

RD-05S

SPRINGLESS RECYCLABLE PUMP
5ml

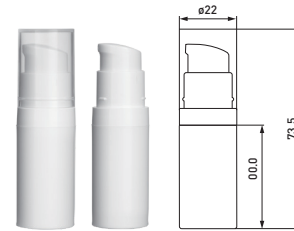

RD-06S

SPRINGLESS RECYCLABLE PUMP
6ml

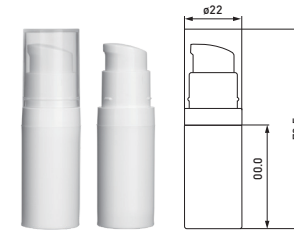

RD-07S

SPRINGLESS RECYCLABLE PUMP
7ml

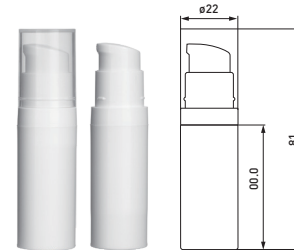

RD-08S

SPRINGLESS RECYCLABLE PUMP
8ml

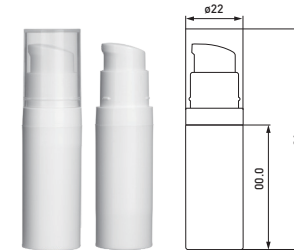

RD-10S

SPRINGLESS RECYCLABLE PUMP
10ml

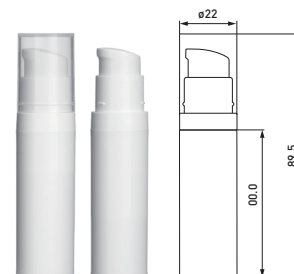

RD-15S

SPRINGLESS RECYCLABLE PUMP
15ml

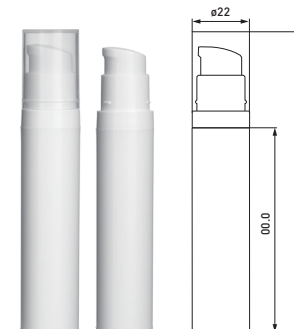

MOLD

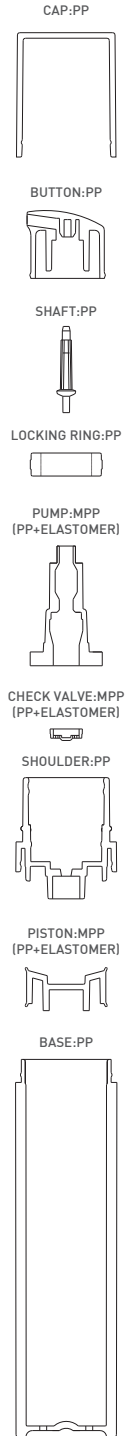

에어리스 펌프

BR TYPE

SPRINGLESS RECYCLABLE PUMP ReDi Series_AIRLES

- # 기본 타입 Spring-less pump
- # Standard type of Spring-less pump



PRODUCT SPECS TABLE

CODE	CAPACITY(ml)	DIAMETER(mm)	HIGH(mm)	PUMP TYPE	DOSAGE(cc)
RD-15BR	15	32.6	110.5	SNAP ON	0.2
RD-30BR	30	32.6	110.5	SNAP ON	0.2
RD-35BR	35	32.6	110.5	SNAP ON	0.2
RD-45BR	45	32.6	134.5	SNAP ON	0.2
RD-50BR	50	32.6	134.5	SNAP ON	0.2
RD-15S	15	32.6	110.5	SNAP ON	0.2

AVAILABLE SIZE

RD-10BR

SPRINGLESS RECYCLABLE PUMP

10ml

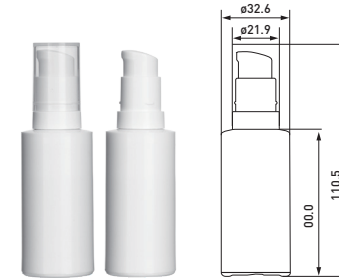

RD-15BR

SPRINGLESS RECYCLABLE PUMP

15ml



RD-30BR

SPRINGLESS RECYCLABLE PUMP

30ml

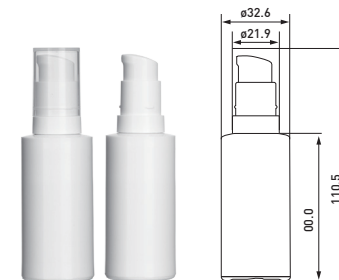

RD-35BR

SPRINGLESS RECYCLABLE PUMP

35ml



RD-45BR

SPRINGLESS RECYCLABLE PUMP

45ml

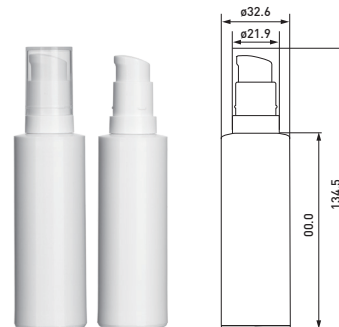

RD-50BR

SPRINGLESS RECYCLABLE PUMP

50ml

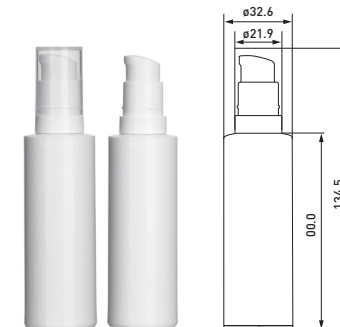

MOLD

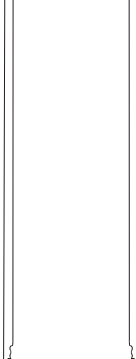
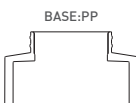
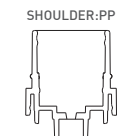
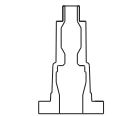
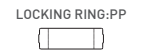
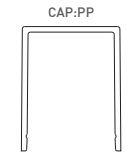

SR+TR TYPE

SPRINGLESS RECYCLABLE PUMP

ReDi Series_AIRLES

고급스러운 일체형 Spring-less pump
Elegance integral Spring-less pump



PRODUCT SPECS TABLE(SR Type)

CODE	CAPACITY(ml)	DIAMETER(mm)	HIGH(mm)	PUMP TYPE	DOSAGE(cc)
RD-30SR	30			SNAP ON	0.2
RD-35SR	35			SNAP ON	0.2
RD-50SR	50			SNAP ON	0.2

PRODUCT SPECS TABLE(TR Type)

CODE	CAPACITY(ml)	DIAMETER(mm)	HIGH(mm)	PUMP TYPE	DOSAGE(cc)
RD-30TR	30			SNAP ON	0.2
RD-35TR	35			SNAP ON	0.2
RD-50TR	50			SNAP ON	0.2

AVAILABLE SIZE

(SR Type)

RD-30SR

SPRINGLESS RECYCLABLE PUMP
30ml

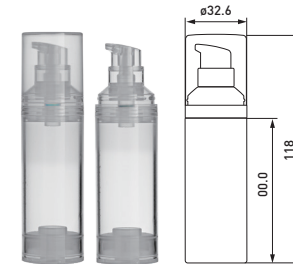

RD-35SR

SPRINGLESS RECYCLABLE PUMP
35ml

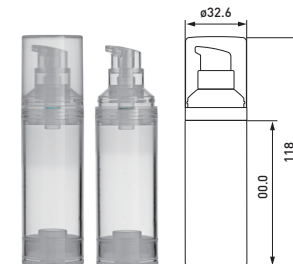

RD-50SR

SPRINGLESS RECYCLABLE PUMP
50ml

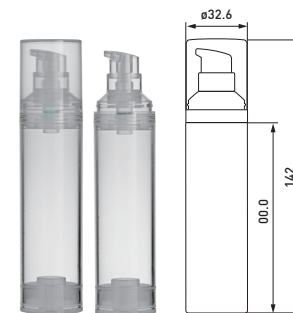

(TR Type)

RD-30TR

SPRINGLESS RECYCLABLE PUMP
30ml



RD-35TR

SPRINGLESS RECYCLABLE PUMP
35ml



RD-50TR

SPRINGLESS RECYCLABLE PUMP
50ml

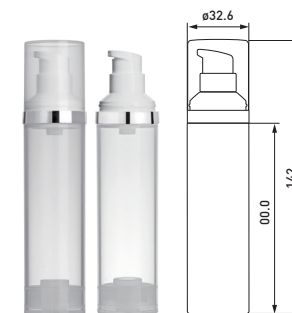

MOLD

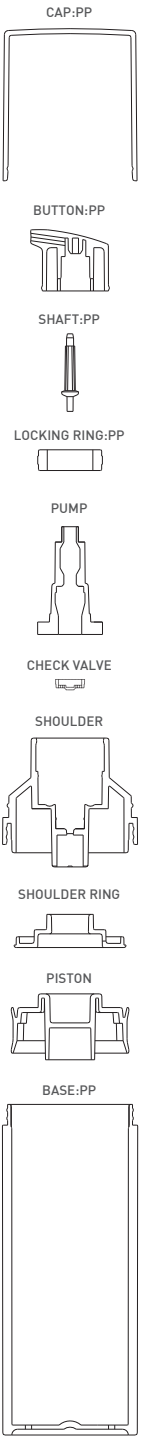

CR TYPE

SPRINGLESS RECYCLABLE PUMP ReDi Series_AIRLES

- # 고점도 Spring-less pump
- # Cream Spring-less pump

WORLD'S FIRST!
Introducing DONGGIPNI
Cream PUMP.
As our viscosity challenge
proves, no viscosity is too
high for DONGGIPNI's springless
recyclable pump!

It is springless, 100%recyclable,
and strong enough to even
pump out balms & toothpaste.

동기피엔아이 ReDi 고점도
펌프는 메탈 재질을 전혀
사용하지 않은 100% 재활용이
가능한 친환경펌프이며,

Balm 타입과 치약까지도 펌핑
이 가능한 점도에 제약이 거의
없는 신개념 패키징입니다

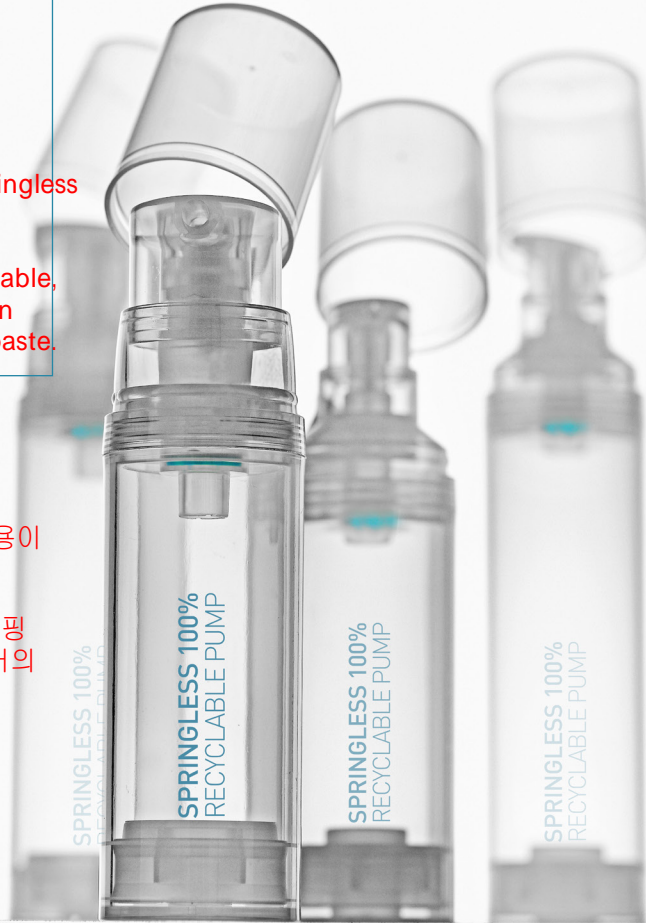

PRODUCT SPECS TABLE(CR Type)

CODE	CAPACITY(ml)	DIAMETER(mm)	HIGH(mm)	PUMP TYPE	DOSAGE(cc)
RD-30CR	30			SNAP ON	0.5 ~ 0.9
RD-35CR	35			SNAP ON	0.5 ~ 0.9
RD-50CR	50			SNAP ON	0.5 ~ 0.9

AVAILABLE SIZE

(CR Type)

RD-30CR

SPRINGLESS RECYCLABLE PUMP
30ml

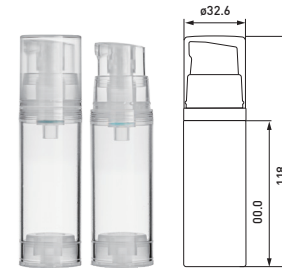

RD-35CR

SPRINGLESS RECYCLABLE PUMP
35ml

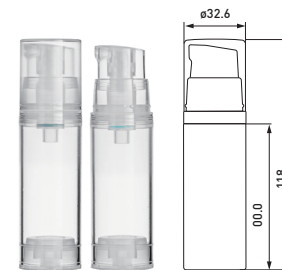

RD-50CR

SPRINGLESS RECYCLABLE PUMP
50ml

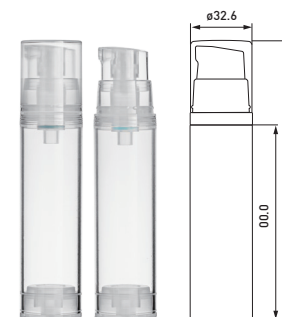

용기 이미지 가운데로 이동 요청

MOLD

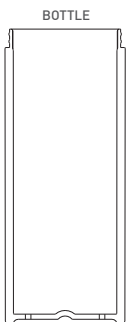
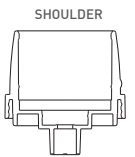
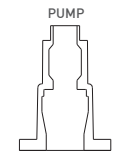
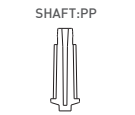
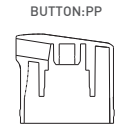
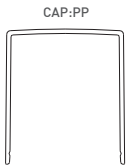

DS+DO TYPE
SPRINGLESS RECYCLABLE PUMP
ReDi Series_DIP TUBE

기본형 브로우 용기 디튜브 타입 Spring-less pump
 # Standard blow type of Dip Tube Spring-less pump



PRODUCT SPECS TABLE(DS Type)

CODE	CAPACITY(ml)	DIAMETER(mm)	HIGH(mm)	PUMP TYPE	DOSAGE(cc)
DGB-30DS	30			screw	0.2
DGB-50DS	50			screw	0.2
DGB-80DS	80			screw	0.2
DGB-100DS	100			screw	0.2

PRODUCT SPECS TABLE(DO Type)

CODE	CAPACITY(ml)	DIAMETER(mm)	HIGH(mm)	PUMP TYPE	DOSAGE(cc)
DGB-30DO	30			screw	0.2
DGB-50DO	50			screw	0.2
DGB-80DO	80			screw	0.2
DGB-100DO	100			screw	0.2

AVAILABLE SIZE

(DS Type)

DGB-30DS

SPRINGLESS RECYCLABLE PUMP

30ml



DGB-50DS

SPRINGLESS RECYCLABLE PUMP

50ml



DGB-80DS

SPRINGLESS RECYCLABLE PUMP

80ml

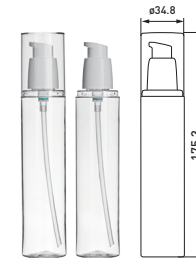

DGB-100DS

SPRINGLESS RECYCLABLE PUMP

100ml

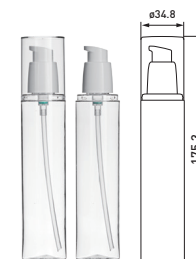

(DO Type)

DGB-30DO

SPRINGLESS RECYCLABLE PUMP

30ml



DGB-50DO

SPRINGLESS RECYCLABLE PUMP

50ml



DGB-80DO

SPRINGLESS RECYCLABLE PUMP

80ml

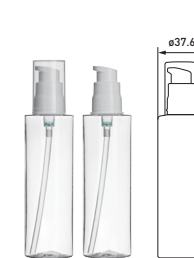

DGB-100DO

SPRINGLESS RECYCLABLE PUMP

100ml

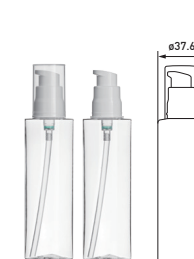

MOLD

CAP:PP

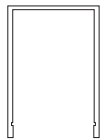

BUTTON:PP



SHAFT:PP



LOCKING RING:PP

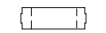

PUMP:MPP
(PP+ELASTOMER)

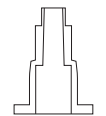

조립도
교환 필요

CHECK VALVE:MPP
(PP+ELASTOMER)



SHOULDER:PP

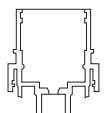

PISTON:MPP
(PP+ELASTOMER)



BASE:PP

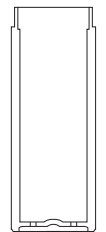

딥 튜브

MO+MR TYPE

SPRINGLESS RECYCLABLE PUMP
ReDi Series_DIP TUBE

브로우 타입 미스트 Spring-less pump
Blow type MIST of Spring-less pump



PRODUCT SPECS TABLE(MIST / MO Type)

CODE	CAPACITY(ml)	DIAMETER(mm)	HIGH(mm)	PUMP TYPE	DOSAGE(cc)
DGB-30MO	30			screw	0.2
DGB-50MO	50			screw	0.2
DGB-80MO	80			screw	0.2
DGB-100MO	100			screw	0.2

PRODUCT SPECS TABLE(MIST / MR Type)

CODE	CAPACITY(ml)	DIAMETER(mm)	HIGH(mm)	PUMP TYPE	DOSAGE(cc)
DGB-30MR	30			screw	0.2
DGB-50MR	50			screw	0.2
DGB-80MR	80			screw	0.2
DGB-100MR	100			screw	0.2

AVAILABLE SIZE

(MIST / MO Type)

DGB-30MO

SPRINGLESS RECYCLABLE PUMP
30ml

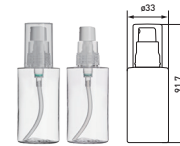

DGB-50MO

SPRINGLESS RECYCLABLE PUMP
50ml

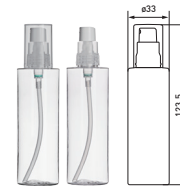

DGB-80MO

SPRINGLESS RECYCLABLE PUMP
80ml

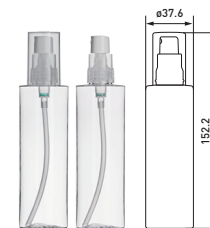

DGB-100MO

SPRINGLESS RECYCLABLE PUMP
100ml

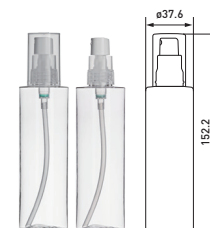

(MIST / MR Type)

DGB-30MR

SPRINGLESS RECYCLABLE PUMP
30ml



DGB-50MR

SPRINGLESS RECYCLABLE PUMP
50ml

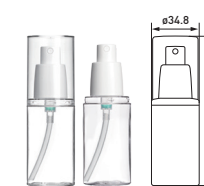

DGB-80MR

SPRINGLESS RECYCLABLE PUMP
80ml

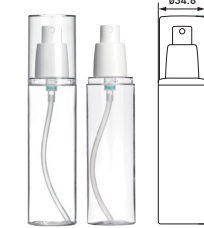

DGB-100MR

SPRINGLESS RECYCLABLE PUMP
100ml

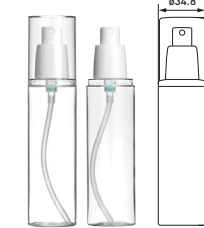

MOLD

CAP:PP

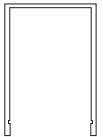

BUTTON:PP



SHAFT:PP



LOCKING RING:PP



PUMP:MPP
(PP+ELASTOMER)

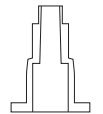

조립도
교환 필요

CHECK VALVE:MPP
(PP+ELASTOMER)



SHOULDER:PP

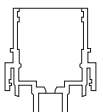

PISTON:MPP
(PP+ELASTOMER)



BASE:PP

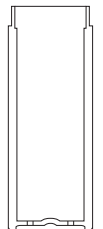



**SPRINGLESS RECYCLABLE PUMP
ReDi Series_PUMP
for 18(파이 기호 삽입) blow cantainer**

AVAILABLE SIZE

DG-18DR

SPRINGLESS
RECYCLABLE PUMP

0.2 cc



DG-18KR

SPRINGLESS
RECYCLABLE PUMP

0.2 cc



DG-18MS

SPRINGLESS
RECYCLABLE PUMP
MIST Type



DG-18DO

SPRINGLESS
RECYCLABLE PUMP

0.2 cc



DG-18KO

SPRINGLESS
RECYCLABLE PUMP

0.2 cc



DG-18MO

SPRINGLESS
RECYCLABLE PUMP
MIST Type



DG-18DS

SPRINGLESS
RECYCLABLE PUMP

0.2 cc



DG-18KS

SPRINGLESS
RECYCLABLE PUMP

0.2 cc



DG-18MG

SPRINGLESS
RECYCLABLE PUMP
MIST Type



DG-18DG

SPRINGLESS
RECYCLABLE PUMP

0.2 cc



DG-18KG

SPRINGLESS
RECYCLABLE PUMP

0.2 cc



크림용기

CREAM JAR SINGLE CAP

원형 단캡 크림 용기
내용기 교체로 30/50g 사용 가능하며,
내용기가 외용기를 덮고 있어, 내용물이 외캡에 직접 접촉하지
않도록 방지해 줍니다.



PRODUCT SPECS TABLE (SINGLE CAP)

CODE	CAPACITY	DIAMETER(mm)	HIGH(mm)	CAP TYPE
DGD-S30JA	30g / 50g			SINGLE
DGT-S30JA	30g / 50g			SINGLE
DGO-S30JA	30g / 50g			SINGLE
DGTP-S30JA	30g / 50g			SINGLE
DGD-J50JA	50g/80g/100g			SINGLE
DGTP-J50JA	50g/80g			SINGLE

PRODUCT SPECS TABLE(샘플 용기)

CODE	CAPACITY	DIAMETER(mm)	HIGH(mm)	CAP TYPE
DGD-S05JA	5g			SINGLE
DGD-S10JA	10g			SINGLE

AVAILABLE SIZE

PRODUCT SPECS TABLE(단캡 용기)

DGD-S30JA DGD-S50JA

30/50g

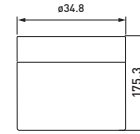

DGO-S30JA DGO-S50JA

30/50g

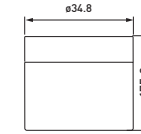

DGT-S30JA DGO-S50JA

30/50g

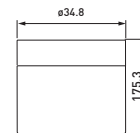

DGTP-S30JA DGTP-S50JA

30/50g

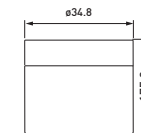

DGD-J50JA DGD-J80JA DGD-J100JA

50/80/100g

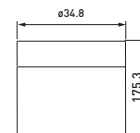

DGTP-J50JA DGTP-J80JA

50/80g

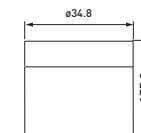

PRODUCT SPECS TABLE(샘플 용기)

DGD-S05JA

5g

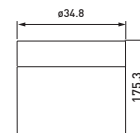

DGD-S10JA

10g

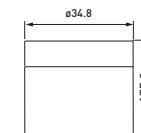

CREAM JAR DOUBLE CAP

이중캡 크림 용기

특히 기술 냉각방식으로 사출된 상캡은 고급스러운 무게감을 지니고 있습니다.



AVAILABLE SIZE

DGC-C50JA

50g

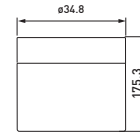

DGC-R50JA

50g

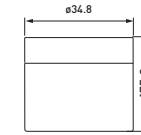

DGR-C50JA

50g

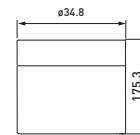

DGR-R50JA

50g

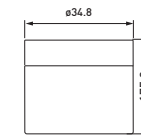

DGD-C50JA

50g

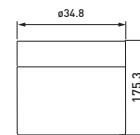

DGD-R50JA

50g



사진 교체

PRODUCT SPECS TABLE (DOUBLE CAP)

CODE	CAPACITY	DIAMETER(mm)	HIGH(mm)	CAP TYPE
DGC-C50JA	50g			DOUBLE
DGC-R50JA	50g			DOUBLE
DGR-C50JA	50g			DOUBLE
DGR-R50JA	50g			DOUBLE
DGD-C50JA	50g			DOUBLE
DGD-R50JA	50g			DOUBLE

Family Series

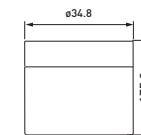
DOUBLE WALL

Pump type and Overcap are optional !!



PRODUCT SPECS TABLE

CODE	CAPACITY	DIAMETER(mm)	HIGH(mm)
DGT-1300R	130ml		
DGT-1200R	120ml		
DGT-500R	50ml		
DGD-J50JA	50g		
DGD-S30JA	30g		

026 COSMETICS CONTAINER MANUFACTURER

AVAILABLE SIZE

DGT-120/1300R

130/120ml

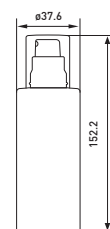

DGTP-500R

50ml

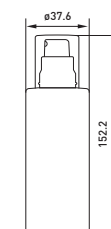

DGD-S30JA

30g

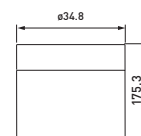

DGD-J50JA

50g

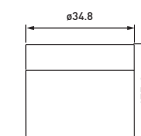

COSMETICS CONTAINER MANUFACTURER **027**

Family Series

POLYGON FAMILY

Pump type and Overcap are optional !!



PRODUCT SPECS TABLE

CODE	CAPACITY	DIAMETER(mm)	HIGH(mm)
DGTP-1300R	130ml		
DGTP-1200R	120ml		
DGTP-500R	50ml		
DGTP-J50JA	50g		
DGTP-S30JA	30g		

028 COSMETICS CONTAINER MANUFACTURER

AVAILABLE SIZE

DGT-120/1300R

130/120ml

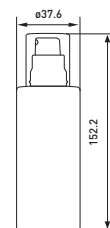

DGTP-500R

50ml

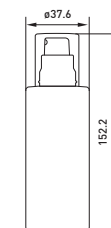

DGTP-S30JA

30g

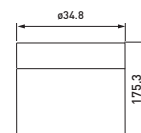

DGTP-J50JA

50g

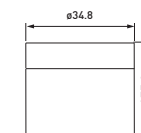

COSMETICS CONTAINER MANUFACTURER **029**

Family Series

LUXE BLOW

Pump type and Overcap are optional !!



PRODUCT SPECS TABLE

CODE	CAPACITY	DIAMETER(mm)	HIGH(mm)
DGB-130DR	130ml		
DGB-120DR	120ml		
DGB-80CR	80ml		
DGB-50DR	50ml		

AVAILABLE SIZE

DGB-130DR

130ml

펌프 용기 하나 삭제 하시고
위에서 세로로 용기 나열 요청

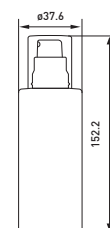

DGB-50DR

50ml

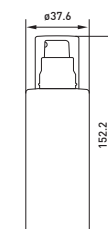
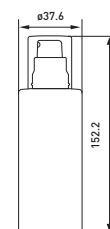

DGB-80CR

80ml

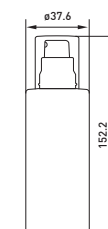





www.donggipni.com

COSMETICS CONTAINER MANUFACTURER

 **동기파이엔아이**

[HQ] 경기도 시흥시 금오로 309번길 4

[FTY] 경기도 화성시 마도면 마도공단로 2길19

TEL (070)4195-9223 FAX (031) 355-8360

